



TOPTABLE HOB

Barcode : 8851737034385

Model name : HP35-1SIR/FGB

DETAILS:

Safety	Flame failure device with quick acting thermocouple
Ignition	Electric ignition under knob (one hand ignition)
Gas type	LPG
Gas working pressure	0.04 kg/cm ²
Gas inlet port (connect with LPG hose)	Ø 9.5 mm.
Cabinet	900 mm.
Type of installation	Inset into the worktop from above
Minimum clearance between cooktop and hood	700 mm.
Minimum clearance between furniture	150 mm. with thermal insulation fitted
Recommendation	For the appliance with more than 12kW, room ventilation, room size and hood must be observed

Technical Drawing

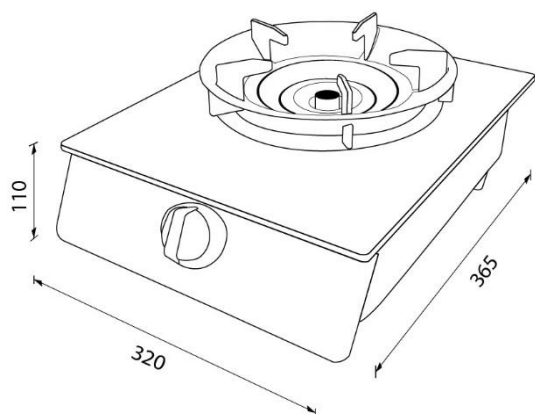

Technical detail

Dimension : 320 x 365 x 110 mm.

Weight Gross : 4.2 Kg.